

Varenummer: 4395000951
Beskrivelse: Rota-fix spændelement F95x135
Rustfast stål

Mål

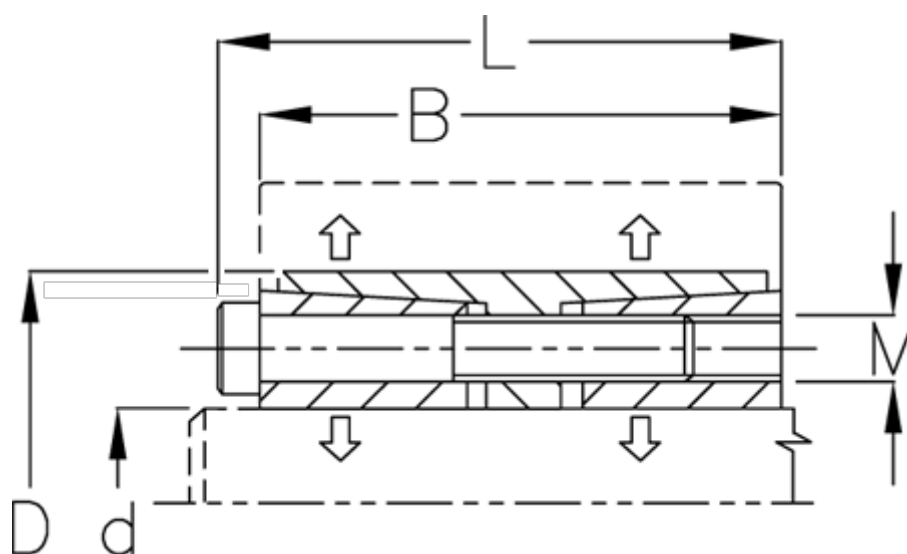

B mm	= 80
d H8 mm	= 95
D mm	= 135
F kN aksialkraft	= 215.0
L mm	= 90
M mm	= M10
Overfladeruhed	= R? ? 3.2 μ m
P N/mm ² fladetryk på aksel/nav	= 36

T Nm drejningsmoment	= 10200
Tolerance	= Aksel h8, Nav H8
Ts Nm boltetilspændingsmoment	= 58.0